

YONGNUO

YNRAY200

摄 像 灯
Pro LED Video Light



使用说明书
User Manual

中文
English

前言

感谢您使用永诺产品！

在使用产品前，请认真阅读使用说明书，并妥善保管以便将来查看。

注意事项

- 1.请保管好本产品，请勿让儿童接触，勿放置在儿童活动之处。
- 2.请在有人员看管时使用本产品，无人看管时应断电产品。
- 3.在使用产品前，请确认电源电压和本产品所标识的电压是否符合。
- 4.建议使用永诺提供的原厂线缆或出售的配件。
- 5.产品接通电源线时，请妥当放置电源线，避免绊倒人员或拉扯造成断电，勿放置在高温或潮湿表面。
- 6.产品运行时，请勿遮挡散热孔，以免散热效果差从而损坏产品。
- 7.产品运行时，强光源照射，切勿直视灯珠，以免引起眼睛不适。
- 8.产品运行时，灯珠会处于发热状态，切勿触摸，以免造成烫伤。
- 9.当产品出现高温报警时，请检查风扇是否出现故障。
- 10.产品应保持干燥环境下使用，产品没有防水防火性能，避免在高温、雨天、潮湿、多尘等恶劣环境下使用。
- 11.请勿在化学品、可燃性气体、易燃易爆的环境下使用产品。
- 12.产品存放前，请关机断电，拔出电源线，等待产品完全冷却后，存放至便携包或干燥环境。
- 13.请勿使用已损坏的电源线，以及摔落出现开裂的产品。
- 14.产品不防摔，请小心使用，避免掉落或承受重击。
- 15.在清洁产品前，确保产品断电状态，请使用干软布进行清洁。
- 16.请勿私自拆卸产品，如出现故障须本公司或授权维修人员处理。

产品规格

光源	1颗COB灯珠
色温版本	单色温版本：5600K；双色温版本：2700K-6500K
输出功率	恒功率200瓦（色温变化，功率不变）
外接电源	DC 24V 8.33A,接口尺寸 $\phi 5.5 \times 2.1 \text{mm}$
APP 蓝牙控制	≤50米
2.4G 无线控制	≤100米
光照角度	110°
摄像灯尺寸	25.2*13.7*31.4厘米
平均寿命	50000小时

物料清单

单灯版

包装尺寸：33*32*18.5厘米。

所含物品：摄像灯（1）、说明书（1）。

套装版

包装尺寸：51*22*38厘米。

所含物品：摄像灯（1）、电源适配器（1）、电源线（1）、标准罩（1）、便携箱（1）、说明书（1）。

注：如有缺失请与经销商联系。

亮度测试数据表

双色温	距离	照度	裸灯	(标配) 标准罩
2700K	1米		6720lux	28600lux
	2米		1880lux	5740lux
	3米		967lux	2550lux

双色温	距离	照度	裸灯	(标配) 标准罩
5600K	1米		8440lux	36500lux
	2米		2390lux	7360lux
	3米		1270lux	3200lux

双色温	距离	照度	裸灯	(标配) 标准罩
6500K	1米		8200lux	35600lux
	2米		2310lux	7160lux
	3米		1230lux	3150lux

单色温	距离	照度	裸灯	(标配) 标准罩
5600K	1米		9120lux	34500lux
	2米		2410lux	6830lux
	3米		1260lux	2950lux

*以上测试为平均值，不同灯的亮度有微小差异。

产品结构



安装与使用

- 1、使用电源适配器供电：19~26伏时，最大功率为200瓦；
14~18伏时，最大功率为60瓦。

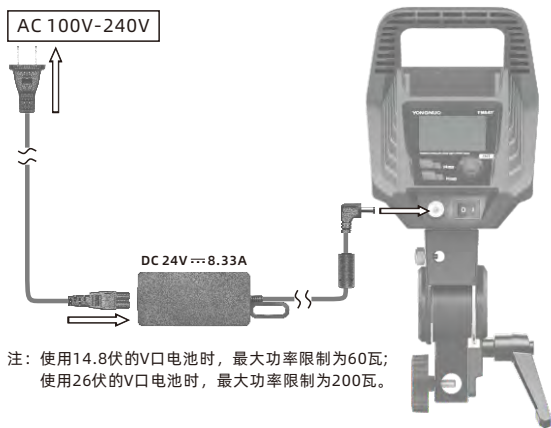

- 2、开机与关机。

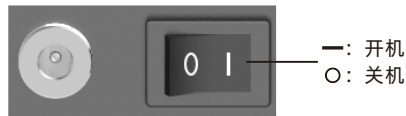

3、色温设置。

按下旋钮切换选择色温与亮度，旋转旋钮调节参数。
(色温调节精准至50K。)

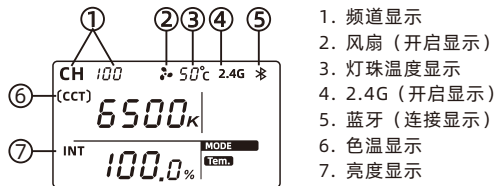

4、四种专业级调光曲线模型设置。

按下<Menu>键，旋转旋钮至 **M** 闪烁，按下旋钮停止闪烁，旋转旋钮选择曲线模型，按下旋钮确认曲线模型。
(注：在菜单完成设置后，按下<Menu>键返回；无操作后，约7秒钟后自动返回。)

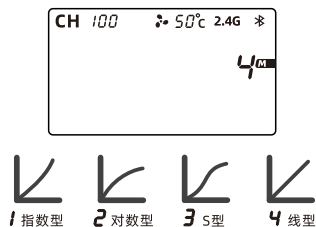

5、频道设置。

按下<Menu>键，选择频道【CH】，按下旋钮确认，旋转旋钮调节频道，按下旋钮确认频道。

(注: CH1-CH8频道兼容承诺早期摄像灯产品，建议使用CH9以上频道，将获得更顺畅的控制体验。)

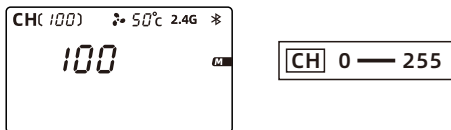

6、特效设置。

按下<Mode>键进入特效模式，按下旋钮切换选择特效模式、速度、亮度，旋转旋钮调节参数；按下<Mode>键返回到色温模式。

(注：单色温版本只有9个特效模式。)

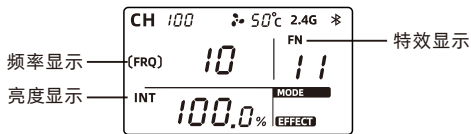

中文



7、多灯编排设置。

- 1、进入编排模式：长按<Mode>键进入。
- 2、编排模式下频道设置：按下<Menu>键，选择频道【CH】，按下旋钮确认，旋转旋钮调节频道，按下旋钮确认频道。
- 3、退出编排模式：屏幕界面显示<sync>，按下<Mode>键退出。
(注：使用编排模式请下载APP操作。)

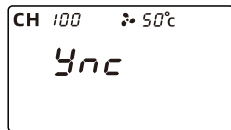

8、风扇设置。

按下<Menu>键，旋转旋钮选择风扇【】，按下旋钮切换选择<on>开启或<off>关闭风扇。

on: 风扇开启时功率200瓦。

off: 风扇关闭时功率降至35瓦。

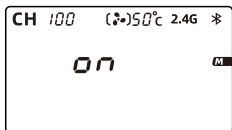

9.安装柔光伞使用。

通过伞孔插入柔光伞，再拧紧伞孔固定旋钮后使用。

(注：柔光伞需另购。)



中文

10、手机APP与遥控器的使用。

- 1).按下<Menu>键，旋转旋钮选择蓝牙【】，按下旋钮切换选择<on>开启蓝牙；此时打开手机APP就可以自动连接摄像灯实现无线控制。
- 2).2.4G无线控制模式可选择开启或关闭。
- 3).APP可以从永诺官网下载或通过扫描彩盒二维码点击下载。

本手册中的功能是依据本公司的测试条件获得，设计和规格如有变更，恕不另行通知。

制造商：深圳市永诺电器有限公司
制造商地址：深圳市坪山区坑梓街道秀新社区锦绣东路14号A1栋209 A座A2栋2-5楼
电话：(86)0755-3300 1023
售后电话：400-001-3888
网址：www.hkyongnuo.com

Introduction

Thank you for using YONGNUO products!
Please read this manual carefully before using the product and keep it properly for future reference.

Precautions

1. Please keep product away from children, do not place it in the children's activity area.
2. Please use this product under supervision, and power off when unsupervised.
3. Before use, please check whether the power voltage fits the voltage marked on the product.
4. It is recommended to use the original cables or accessories provided or sold by YONGNUO.
5. When the power cord is connected, please place it properly to avoid tripping people or blackout, and do not place it on the hot or damp surface.
6. When the product runs, please do not cover the dissipation hole to avoid product damage due to poor dissipation performance.
7. When the product runs, do not look straight at the lamp beads to avoid eyes discomfort due to strong lights.
8. When the product runs, lamp beads are at the heating state, do not touch it to avoid burning.
9. When high-temperature warning occurs, please check whether the fan is faulty.
10. Use this product in dry environment. This product is not waterproof or fireproof. Do not use it in hot, rainy, damp or dusty environment.
11. Do not use this product near chemicals, flammable gases, inflammables and explosives.

12. Before storing the product, please turn off the power, unplug the power cord, wait for the product to cool down completely, and store it in a portable bag or a dry environment.
13. Please do not use the damaged power cord or the cracked product caused by falling off.
14. This product is not fall-proof, please use it carefully to avoid falling down or getting heavy hit.
15. Before cleaning the product, please ensure that the power is turned off, and please use a dry soft cloth for cleaning.
16. Please do not disassemble the product by yourself. In case of failure, problems shall be handled by the company or authorized maintenance personnel.

Product specification

Light Source	One COB lamp bead
Color temperature version	Single color temperature version: 5600K; Bi-color temperature version: 2700K-6500K
Output power	Constant power 200W (Color temperature changes with power unchanged)
External power source	DC 24V \Rightarrow 8.33A、Interface size, ϕ 5.5*2.1mm 
APP Bluetooth control	\leq 50m
2.4G wireless control	\leq 100m
Luminance Angle	110°
Product Net Size	25.2*13.7*31.4CM
Average Service Life	50000H

Check list

Single light version

Package Dimensions: 33*32*18.5CM.

Contents: Video light (1) , User Manual (1) .

Kit version

Package Dimensions: 51*22*38CM.

Contents: Video light (1) , Power adapter (1) , power line (1) , Standard Reflector (1) , Portable case (1) , User Manual (1) .

Note: Please contact your dealer if anything missing.

Photometrics

Bi-color temperature version	Illumination		Single light	(Official accessory) Standard Reflector
	Distance			
2700K	1米	6720lux	28600lux	
	2米	1880lux	5740lux	
	3米	967lux	2550lux	

Bi-color temperature version	Illumination		Single light	(Official accessory) Standard Reflector
	Distance			
5600K	1米	8440lux	36500lux	
	2米	2390lux	7360lux	
	3米	1270lux	3200lux	

Bi-color temperature version	Illumination		Single light	(Official accessory) Standard Reflector
	Distance			
6500K	1米	8200lux	35600lux	
	2米	2310lux	7160lux	
	3米	1230lux	3150lux	

Single color temperature version	Illumination		Single light	(Official accessory) Standard Reflector
	Distance			
5600K	1米	9120lux	34500lux	
	2米	2410lux	6830lux	
	3米	1260lux	2950lux	

* This is an averaged result, the number might be slightly different on each light.

Product structure

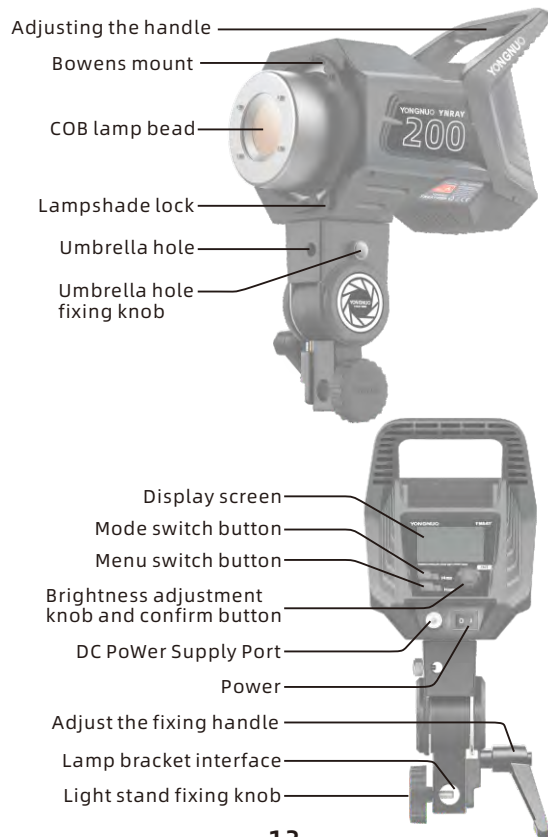

Installation and use

1.Powered by power adapter:

When the voltage is in the range of 19-26V, the maximum power is 200w;
When the voltage is in the range of 14~18V, the maximum power is 60W.

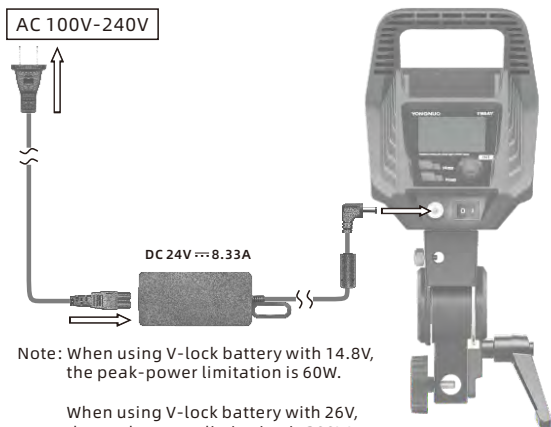

2.Power ON or OFF.



3.Color Temperature Setting.

Press the knob to switch color temperature and brightness, and rotate the knob to adjust the parameters.
(Color temperature is adjusted accurately to 50K.)

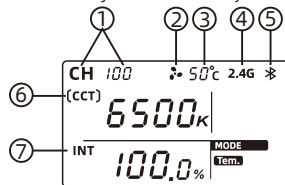

1. Channel Display.
2. Fan(Switch Display).
3. Lamp Bead Temperature Display.
4. 2.4G(Switch Display).
5. Bluetooth (Connection Display)
6. Color Temperature Display.
7. Brightness Display.

4.4 kinds of professional-grade dimming curve models settings.

Press the button <Menu>, rotate the knob until **M** blinks, press the button to stop blinking, rotate the knob to choose dimming curve model and press the knob to confirm.

(Note: After the menu is set, press the <Menu> key to return; It will return automatically after about 7 seconds without operation.)

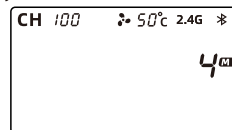

1 Exponential



2 Logarithmic



3 S-shaped



4 Linear

5. Channel Setting.

Press the <Menu> key , select the channel [CH] ,then press the the knob to confirm,rotate the knob to adjust the channel then press the knob to confirm the channel.
(Note: CH1-CH8 channels are compatible with YONGNUO's early video light products, we recommend to use channels above CH9 for a smoother control experience.)

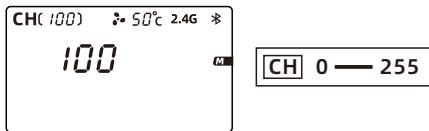

6. Effects Setting.

Press the <Mode> key to enter the special effect mode, press the knob to switch and select the special effect mode,speed and brightness, and rotate the knob to adjust the parameters; press the <Mode> key to return to the color temperature mode.
(Note: 9 special modes for white version.)

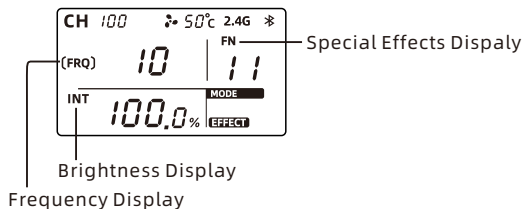

7. Multiple lights layout mode setting.

- 1、 Enter the layout mode: Long press <Mode> to enter.
- 2、 Switching channels in layout mode: Press the <Menu> key , select the channel [CH] ,then press the the knob to confirm,rotate the knob to adjust the channel then press the knob to confirm the channel.
- 3、 To exit the layout mode: <ync> is displayed on the screen interface, press the <Mode> key to exit.
(Note: Please download APP for using layout mode.)

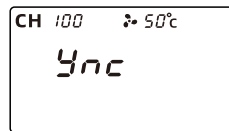

8. Fan setting.

Press the <Menu> key, rotate the knob to select the fan [🌀], press the knob to select <on> to turn on or <off> to turn off the fan.

on: The power is 200W when the fan is on.

off: The power is reduced to 35 Watts when the fan is off.

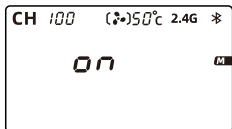

9. Install the soft light umbrella for use.

Insert the soft light umbrella through the umbrella hole, then tighten the umbrella hole fixing knob before use.
(Note: The soft light umbrella needs to be purchase separately.)



10. Use via mobile APP and remote control for wireless control.

- 1). Press the <Menu> key and rotate the knob to select Bluetooth [📶], press the knob to select <on> to turn on Bluetooth; and open the mobile APP to automatically connect to the video light to realize wireless control.
- 2). 2.4G wireless control mode can be selected to turn on or off.
- 3). The APP can be downloaded from the YONGNUO official website or scanning the QR code on the gift box.

The functions in this manual are based on the test conditions our company.

Further notice will not be given if the design and specifications change.



APP 下载
APP Download



永诺官网
YONGNUO Web