

YONGNUO

YNRAY360

摄像机
Pro LED Video Light

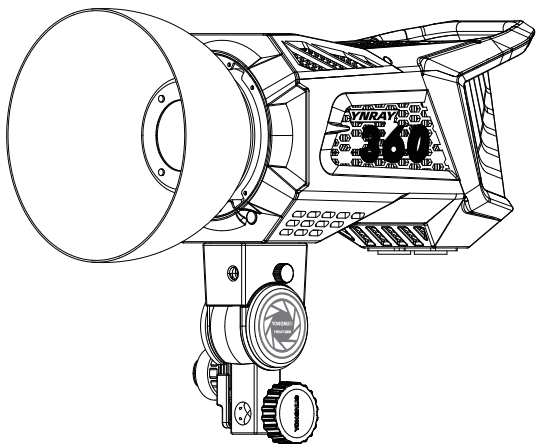

使用说明书

User Manual

前言

感谢您使用YNRAY360摄像机，在使用产品前，请认真阅读使用说明书。

注意事项

- 严禁将产品靠近或者投入火源，以避免发生火灾及爆炸等危险。
- 请勿私自拆卸产品，如产品出现故障须本公司或授权维修人员处理。
- 本产品运行时，请勿直视COB灯珠，勿遮挡散热孔，勿触摸COB灯珠；设备运行时，请勿直视光线。
- 请勿在易燃易爆和暴露雨中中使用。
- 当摄像机出现高温报警时，请检查风扇是否出现故障。

产品规格

光源	1颗COB灯珠			
色温	双色版本：3200K-5600K；单色版本：5600K			
输出功率	LED：360瓦			
照度 (含标准罩)	距离	1M	2M	3M
	单色	117772Lux	19297Lux	8009Lux
	双色4000K	115946Lux	16165Lux	7190Lux
含包装重量	约7673克	摄像机重量	约2796克	
外接电池	26V/7A或14.8V/7A-V口电池接口*2			
外接电源	DC 24V/7.5A*2			
包装尺寸	450*450*325MM	摄像机尺寸	435*171*321毫米	
遥控距离	小于15米			
平均寿命	50000小时			
光照角度	110°			
所含物品：摄像机(1)、电源适配器(2)、标准罩(1)、电源线/2米(1)、Y型AC延长线/3.5米(1)、电箱(1)、便携包(1)。 注：如有缺失请与经销商联系。				

*注：使用14.8V的V口电池时，最大功率限制为160w。使用26V的V口电池时，最大功率限制为360w。

*屏幕显示的温度为COB工作温度。

产品结构

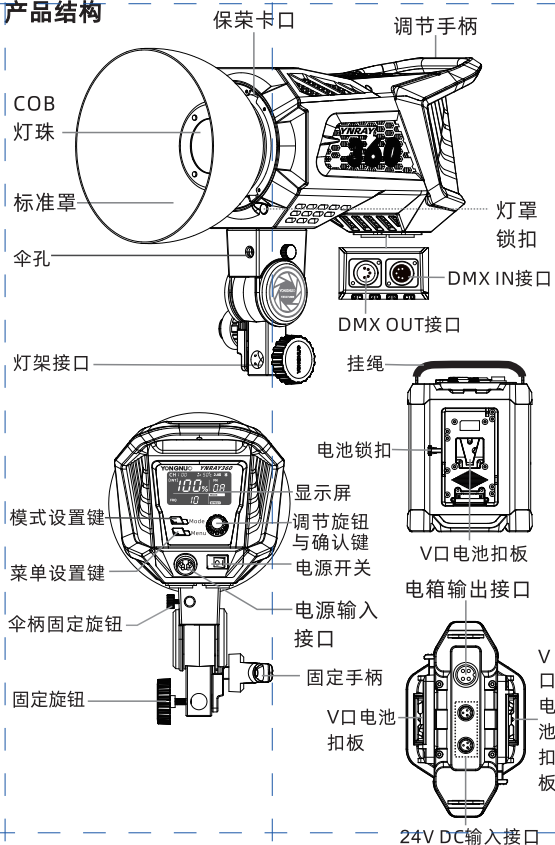

-2-

安装与使用

1、供电使用。

1) 使用两个配置电源适配器供电。

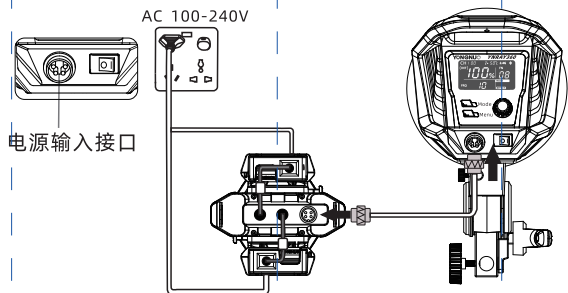

2) 使用电池供电。(使用电池供电时, 请将AC电源拔掉;
且AC电源供电时不对电池充电。)

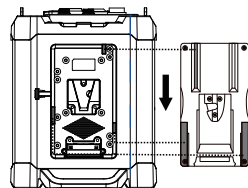

2、开机与关机。

按下开关机键进行开关机。

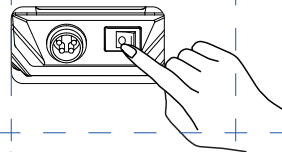

-3-

3、色温与亮度调节。

按下开机摄像灯点亮，按下旋钮切换色温与亮度调节选项，旋转旋钮调节参数。



4、切换频道。

按下<Menu>按钮旋转确认键选择频道[CH]菜单，按下确认键旋转旋钮调节到您所需要的频道；按下确认键完成切换。（注：产品分为256个频道）

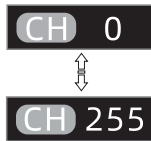

5、特效模式。

按下<Mode>按钮进入特效模式，按确认键切换特效模式、速度、亮度选项，旋转调节参数。再次按下<Mode>切换到色温模式。



闪电



SOS



坏灯泡



电影荧幕反光



白灯呼吸



日出



狗仔队



爆炸



黄灯呼吸



频闪



烟花



色温循环

6、设置风扇开关。

按下< Menu >按钮，旋转旋钮选择风扇图标，按下确认键选择开关。ON：风扇开启时功率达到360瓦。OFF：风扇关闭时功率降低至72瓦。调节亮度参数超过20%时，风扇图标闪烁。

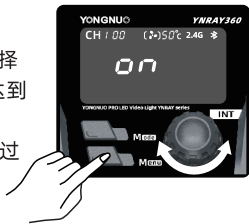

7、DMX模式。

1)，连接标准DMX控制台与YNRAY360。

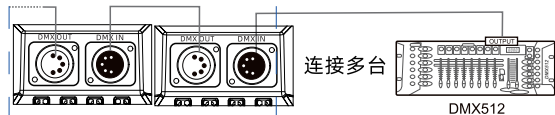
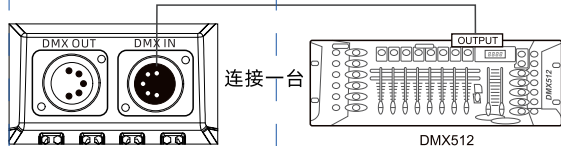

2), DMX接口定义如图所示：

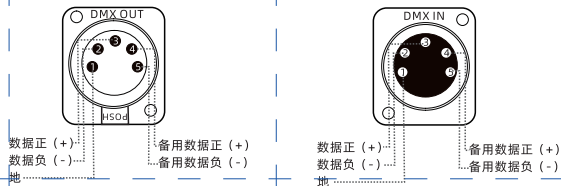

B)，DMX控制台与YNRAY360连接。长按<Mode>按键4秒，进入DMX控制模式。按下确认键切换<D>DMX地址和<F>DMX功能选择，旋转确认键调节参数。短按<Mode>按键退出DMX模式。

(注：进入DMX模式后，蓝牙和2.4G无线控制不可使用，Menu按键按下无功能；且不连接DMX控制线的情况下具备DMX无线控制功能。)

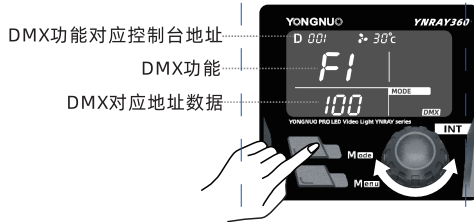

4), DMX功能实用表。

DMX实用表 (双色)			
DMX频道值-功能对应表(5个频道)			
DMX功能	频道 (地址码)	数值	功能
F1	假如设001	0-255	总亮度调节 0-100%
F2	假如设002	0-255	5600K 线性调光 0-100%
F3	假如设003	0-255	3200K 线性调光 0-100%
F4	假如设004	线性调光数值	光效控制
		1-20	闪电
		21-40	荧幕反光
		41-60	狗仔队
		61-80	频闪
		81-100	SOS
		101-120	白色呼吸
		121-140	爆炸
		141-160	烟花
		161-180	坏灯泡
		181-200	日出
		201-220	黄色呼吸
		221-255	色温循环
F5	假如设005	—	速度调节 (光效)
		0-255	1-10档位

DMX实用表 (单色)

DMX实用表 (单色)			
DMX频道值-功能对应表(4个频道)			
DMX功能	频道 (地址码)	数值	功能
F1	假如设001	0-255	总亮度调节 0-100%
F2	假如设002	0-255	线性调光 0-100%
F3	假如设003	线性调光数值	光效控制
		1-20	闪电
		21-40	荧幕反光
		41-60	狗仔队
		61-80	频闪
		81-100	SOS
		101-120	白色呼吸
		121-140	爆炸
		141-160	烟花
		161-180	坏灯泡
F4	假如设004	—	速度调节 (光效)
		0-255	1-10档位

8、安装柔光伞使用。

通过伞孔接入柔光伞，再拧紧固定旋钮便可使用。

(注：柔光伞需另购)

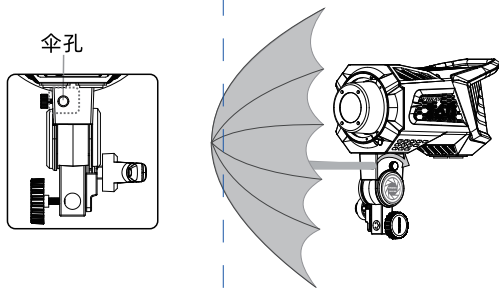

9、手机APP与遥控器的使用。

- 1) .按下<Menu>按键旋转调节旋钮选择蓝牙<☑>,按下确认键开启蓝牙；此时打开手机APP就可以自动连接摄像灯实现无线控制。
- 2) .2.4G无线控制模式可选择开启或关闭。
- 3) .APP可以从永诺官网下载或通过扫描彩盒二维码点击下载。(注：遥控器需另购)



蓝牙 OFF



蓝牙 ON



2.4G OFF



2.4G ON

本手册中的功能是依据本公司的测试条件获得，设计和规格如有变更，恕不另行通知。

深圳市永诺摄影器材股份有限公司

地址：深圳市坪山区坑梓街道深福保现代光学厂区A座

电话：(86) 0755-83762448

传真：(86) 0755-83762765

网址：www.hkyongnuo.com

生产地址：深圳市坪山新区坑梓街道锦绣中路14号

深福保现代光学厂区A栋厂房

售后电话：400-001-3888

Introduction

Thank you for using YNRAY360 LED video light. Please read the manual carefully before you use it.

Precautions

- Do not put the product close to or throw it into the fire source to avoid the danger of fire and explosion.
- Do not disassemble the product, maintenance or repair of this product should be handled by technical maintenance personal of our company or authorized technical maintenance personal.
- When the product is running, please do not look directly at the COB lamp beads, do not cover the heat emission hole, and do not touch the COB lamp beads; When the device is running, do not look directly at the light.
- Do not use this product in flammable and explosive place, or where it can be exposed to moisture.

Product specification

Color temperature version	One COB lamp bead			
Light Source	Bi-color: 3200k-5600k; White: 5600k			
Output power	LED: 360W			
100% illumination (standard cover)	Distance	1M	2M	3M
	White	11772Lux	19297Lux	8009Lux
Package Weight	Bi-color 4000K	115946Lux	16165Lux	7190Lux
	Approx 7673g	Product Net Weight	Approx 2796g	
Compatible batteries	Two 26V/7A ; 14.8V/7A V-lock battery interfac			
External power source	Two DC 24V/7.5A			
Package Dimensions	450*450*325MM	Product Net Size	435*171*321MM	
Control distance	<15M			
Average Service Life	50000H			
Luminance Angle	110°			
Contents: Video light (1) ,Power adapter (2), standard cover (1), Power supply cable/2m (1), Y shape AC extend cable/3.5m (1) , Electric box (1) , Portable bag (1).				
Note: Please contact your dealer if anything missing.				

- * Note : When using V-lock battery with 14.8V, the peak-power limitation is 160W. When using V-lock battery with 26V, the peak-power limitation is 360W.
- * The temperature displayed on the screen is the COB working temperature.

Product structure

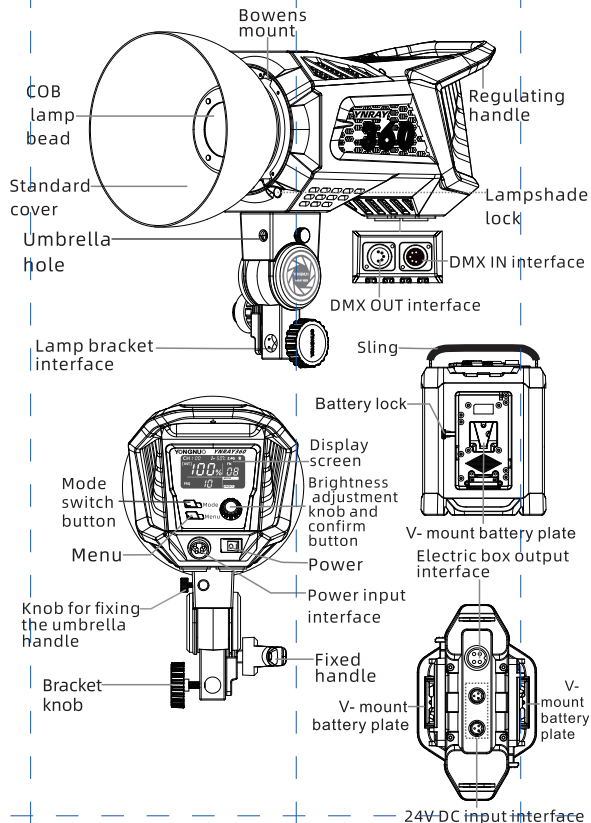

Installation and use

1.The power supply to use.

1) Use two equipped power adapters for power supply.

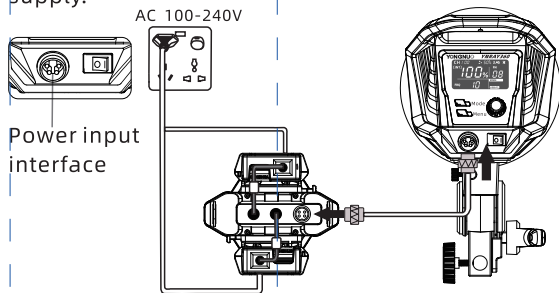

2) Uses battery for power supply. (Please unplug the AC adapter when using the battery, and the battery is not charged when powered by AC adapter.)

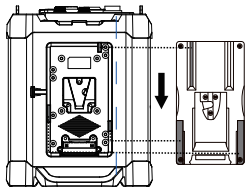

2.Power ON or OFF

Press the power switch to power on or off the LED light.

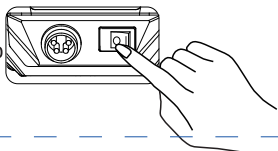

3.Color temperature and brightness adjustment
Press the power button to turn on the light, and press the knob to switch the color temperature and brightness options, rotate the knob to adjust the parameters.



4.Switch channels

Press the button <Menu> and toggle the confirm button to select the channel [CH] menu, then turn the knob to adjust the channel you want; press OK to complete the switch.(Note:The product provides 256 channels.)

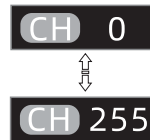

5. Special effect mode

Press <Mode> button to enter special effect mode, press confirm button to switch the special effect mode, speed and brightness options, turn the knob to adjust the parameter. Press <Mode> again to switch to the color temperature mode.

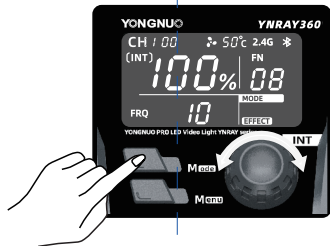

Simulated lighting



SOS



The bad light bulb



Film screen reflection



White breathing light



Sunrise



Paparazzi



The explosion



Yellow breathing light



Strobe



Fireworks



Temperature cycle

6. Fan switch setting

Press <Menu> button, turn the knob to choose the fan icon, press confirm button to select the switch. ON: The power reaches 360W when the fan is on. OFF: The power is reduced to 72W when the fan is off. The fan icon will blink when the brightness adjustment parameter is over 20%.



7. DMX mode

1). Connect the standard DMX console with YNRAY360.

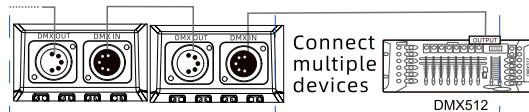
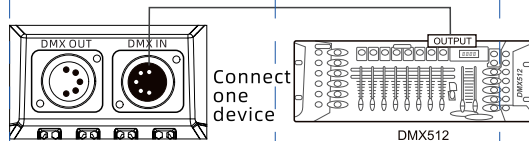

2). The definition of DMX interface is shown in the picture:



3). Connect DMX console with YNRAY360.
 Long press the <Mode> button for 4 seconds to enter the DMX control mode. Press the confirm button to switch the <D>DMX address and <F>DMX function selection, rotate the confirm button to adjust the parameters. Short press the <Mode> button to exit DMX mode.
 (Note: After entering DMX mode, Bluetooth and 2.4G wireless control are not available, no function operates when the Menu button is pressed. And it has DMX wireless control function even in the circumstance that the DMX control line is not connected.)

The corresponding console address of DMX function
 DMX function
 The corresponding address data of DMX

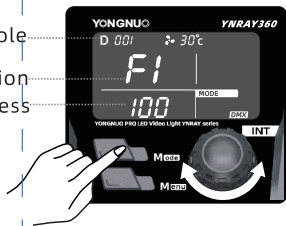

4).DMX function utility tables

DMX utility tables (Bicolor)			
DMX channel value - function corresponding tables (5 channels)			
DMX Function	Channel (address code)	Value	Function
F1	If set 001	0-255	Total brightness adjustment
			0-100%
F2	If set002	0-255	5600K Linear dimming
			0-100%
F3	If set003	0-255	3200K Linear dimming
			0-100%
F4	If set004	Linear adjustment value	Lighting effect control
			1-20 Simulated lightning
			21-40 Film screen reflection
			41+60 Paparazzi
			61-80 Strobe
			81+100 SOS
			101-120 White breathing light
			121-140 The explosion
			141-160 Fireworks
			161-180 The bad light bulb
181-200 Sunrise			
201-220 Yellow breathing light			
221-255 Temperature cycle			
F5	If set005	0-255	Speed adjustment (lighting effect)
			1-10 gears

DMX utility tables (White)

DMX channel value - function corresponding tables (4 channels)

DMX Function	Channel (address code)	Value	Function
F1	If set 001	0-255	Total brightness adjustment
			0-100%
F2	If set002	0-255	Linear dimming
			0-100%
F3	If set003	Linear adjustment value	Lighting effect control
		1-20	Simulated lightning
		21-40	Film screen reflection
		41-60	Paparazzi
		61-80	Strobe
		81-100	SOS
		101-120	White breathing light
		121-140	The explosion
		141-160	Fireworks
		161-180	The bad light bulb
F4	If set004	181-255	—
		Speed adjustment (lighting effect)	
F4	If set004	0-255	1-10 gears

8. Install the soft light umbrella for use
Mount the soft light umbrella via umbrella hole, then tighten the fixed knob to use.

(Note: The soft light umbrella needs to be purchase separately.)

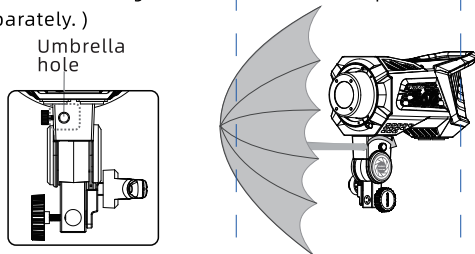

9. Use via mobile APP and remote control for wireless control

1). Press the menu button < * > and toggle the OK button to select bluetooth, press OK button to turn on bluetooth; open the mobile APP ,at this time the video light is connected automatically to realize wireless control.
2). 2.4G wireless control mode can be selected to turn on or off.

3) The APP can be downloaded from the YONGNUO official website or scanning the QR code on the gift box.



Bluetooth
OFF



Bluetooth
ON



2.4G OFF



2.4G ON

The functions in this manual are based on the test conditions our company. Further notice will not be given if the design and specifications change.