

Warning

To avoid fire or electrical shock, do not expose this product to rain or moisture.

To avoid short circuit, please sure the batteries contacts are securely packed and in accordance with local provisions when handling the battery.

Please place the batteries and the parts which can be swallowed mistakenly away from children. Contact a doctor immediately when it occurs.

To avoid possible injury to eyes, do not use the flash light in a short distance from the eyes.

To avoid possible safety accident, do not use the flash light on the people who need a high degree of attention.

- This product is dropped or shocked seriously and the inner part of this product is bared.
- Wear gloves and take the batteries out if the corrosive liquid inside the batteries leaks.
- This product gives off strange smell, heat or smokes.

Do not disassemble or maintain this product because the internal high voltage circuit may cause the electric shock.

Please take out all the batteries if this product is not used for a long time.

Features

● Supports C' s Optical Transportation wireless Master Flash

In the optical transportation wireless flash shooting, the YN568EX III can used as master unit to trigger the YONGNUO and C' s EX series speedlite(except the YN585EX),supports 4 channels,realize wireless TTL,manual flash and stroboscopic flash.

● Compatible With C and N' s Optical Transportation Wireless Slave Flash

One YN568EX III can respectively accept the master unit of

Features

YN600EX-RT II, YN568EX II, YN568EX III, 600EX(II)-RT, 580EX II, SB-910/900/800/700, Nikon internal flash and Canon commander and wireless signal of 7D/60D/600D, realizes external TTL and manual flash and stroboscopic flash.

- **GN58@ISO100, 105mm**

High index TTL flash, support TTL, M, Multi flash.

- **SUPPORTS HIGH-SPPEED SYNC FLASH**

The YN568EX III can synchronize with all shutter speeds, realize TTL and manual flash, the maximum shutter sync is up to 1/8000.

- **Supports Firmware Upgrade**

The YN568EX III is equipped with the USB interface, you can download the latest firmware from YONGNUO official website to upgrade the speedlite,

- **Support the Battery Remaining Power Real-time Display**

The YN568EX III is equipped with the battery electric power display function, allows you to check the battery remaining capacity easily.

- **High Speed Recycling System**

The recycling time for full output just takes 2 seconds; you can get high speed current-return experience even without using brand new batteries, which will only takes 3-4 seconds.

- **Supports Electric Zooming (24~105mm)**

Supports automatic and manual zooming, the focal length can be varied between 24 ~ 105mm.

- **Multiple Trigger Mode Supported**

YN568EX III can be triggered by the camera set-top, PC synchronization trigger and wireless optical trigger off the camera.

- **Automatic Settings Saving, supports custom settings (Fn)**

- **Equipped with Large-size LCD display and 2.5mm PC interface**



Content

Warning	1
Features	1~2
Quick Start	4
Components description	5~7
Product Installation and Remove	8
Basic Functions.....	9~14
Advanced application	15~18
Wireless Flash Shooting.....	19~22
C.Fn:Custom function settings	23~25
Troubleshooting guide.....	26
Specification	27~28

Conventions used in this user manual:



- In order to learn and master the operation of this speed-lite, at the meanwhile you read this manual, please take user manual of your camera as reference.
- In every operating step, we assume that both camera and speed-lite are power on.

Icons used in this user manual

-  : Supplementary information
-  : Long press the button
-  : Short press the button

Quick Start

If you don't have enough time to read the whole user manual, please read this section.

1. Please avoid the excessive use of the output with maximum power. It can effectively extend the service life of this product. (It is recommended that the speedlite should be idle for more than 10 minutes when entering the overheating protection.)
2. Short press the [] button can switch between the front curtain sync, rear curtain sync and high-speed sync.
3. Short press the [MODE] button to switch the TTL/M/Multi mode.
4. Long press the [FN] button to enter the custom function Settings.
5. Short press the [ZOOM] button to enter the focal length adjustment and wireless parameter settings.
6. Long press the [] button to enter the trigger mode selection state.
7. Press the [UP], [DOWN], [LEFT] and [RIGHT] buttons can quickly adjust the parameters of speedlite at the current mode. Some parameters needs selected before adjustment.
8. Hold the [MODE] and [] buttons at the same time, the feature settings and wireless settings of speedlite will restore to the factory default settings.
9. When the speedlite is in shutdown mode, hold the [MODE] button, then turn on, it will enter into firmware update interface.

Components description

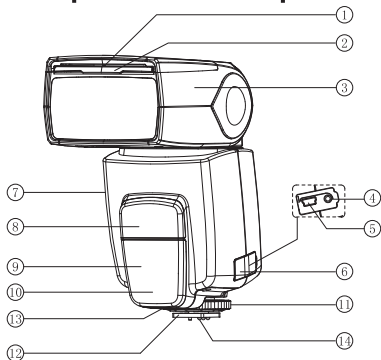

- 1.Reflection board
- 2.Wide-angle diffuser
- 3.Flash head
- 4.PC port (for input)
- 5.USB interface
- 6.Terminal cover
- 7.Battery compartment cover
- 8.Wireless trigger sensor
- 9.Remote indicator
- 10.AF assist beam emitter
- 11.Locking ring
- 12.Hot shoe stand
- 13.Sound port
- 14.Hot shoe contact
- 15.LCD screen

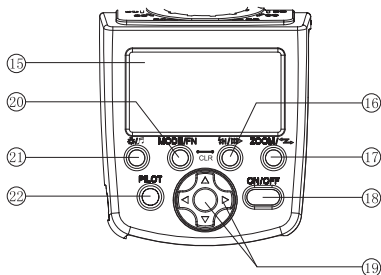

16. :High-speed /rear curtain synchronous button
17. **ZOOM** / :ZOOM button/ Trigger mode switch button
18. **ON/OFF**:Power switch
- 19.Selection/Setting button group
20. **MODE/FN**:Mode/ Custom button
21. :Backlight/sound switch
22. **PILOT** :Charging indicator/ Test button(Pilot)

Components description

M/Multi mode:

Manual flash/Stroboscopic flash

Manual flash output level/
flash exposure compensation mount

: Manual zoom

ETTL/i-TTL mode:

Canon TTL system/Nikon TTL system

: Flash exposure compensation icon

: Exposure bracketing icon

: Master

: Slave

: Master flash enable

: Master flash closed

: Slave flash

Slave grouping

: Channel

: Turn on flash ratio

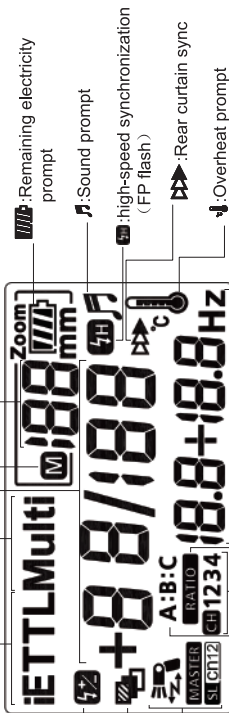

Number of flashes/Flash frequency

Exposure bracketing amount

Manual fine-tuning incremental instructions

Custom option parameters display

Flash light ratio

Meaning of Indicator Light

Status of Charging Indicator	Meaning	Method
Red light	The speed-lite is fully charged and can be used.	Normal.
Blue light	The speed-lite has not been fully charged.	Waiting for completion of charging.
Blue light blinking	A. Low battery; the speed-lite is about to shut down B. Overheat prompt	A. Please replace batteries. B.Reduce flash frequency or stop using the speed-lite until it cools down.
Red light blinking	Overheat prompt	Reduce flash frequency or stop using the speed-lite until it cools down.
Red light and blue light blinking	Overheat protection mechanism is activated.	Stop using the speed-lite/shut down the speed-lite until it cools down.

Sound Prompt

The Sound Form	Meaning	Method
Tick twice	The sound indicator is enabled; the speed-lite is started and ready to fire.	Normal
Three ticks, two times	The exposure is possibly excessive.	Adjust exposure compensation or change the shooting condition.
Tick Tick Tick	The exposure is possibly insufficient.	Adjust exposure compensation or change the shooting.
Tick-tick twice -tick twice	The charging has not been completed.	Wait for completion of charging.
Tick-a long sound	The speed-lite is fully charged and can be used.	Normal
Tick continuously and quickly	Low battery; the speed-lite is about to shut down.	Please replace the batteries.
Tick-tick-tick-	The speed-lite is in sleep mode and it shuts down automatically.	Please turn off the speed-lite and restart it.

Product Installation and Remove

1. Install Batteries

Slide the [battery compartment cover] in the direction of the arrow as shown.

Insert the batteries according to the label inside battery chamber and make sure the direction of the battery contact (+/-) is correct.

Close the [battery compartment cover] in the direction of the arrow as shown.



Please use four standard specification AA batteries. To avoid circuit, please do not use damaged batteries.

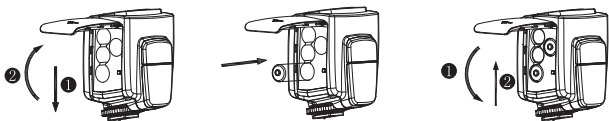

2. Install on the Camera

Loosen the locking ring by rotating it in the direction of the arrow.

Slip the speedlite hot shoe stand into the camera hot shoe stand until it stops

Tighten the locking ring in the direction of the arrow.

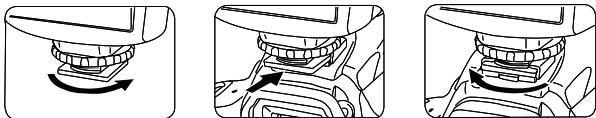

3. Dismantlement

To detach the speedlite, loosen the locking ring, then push it from the camera hot shoe.



Basic Functions

1. Power-on and Power-off

The power of the speedlite can be turned on or turned off by long pressing Power Switch the [ON/OFF] button. It is suggested that the batteries should be taken out after power of speedlite is turned off through this button.

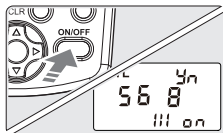

After turning on the power of the speedlite, the charging indicator is on red, which indicates the speedlite is available.

If the charging is not completed within 20 seconds, the low power indicator will with green light blinking; and speedlite will automatically shutdown, indicating it need to be replaced with new batteries.

After use, turn off the speedlite by long pressing the [ON/OFF] button.

2. Test Flash

After the charging indicator on red, you can press the [PILOT] button to test if the speedlite works normally.

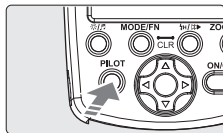

3. E TTL Mode

Short press the [MODE] button to switch the flash mode to E TTL mode. In E TTL mode, the metering system of this camera will detect flash illumination reflected back from the object so as to automatically adjust flash output, and HSS, FEC, FEB, FEV, Rear-curtain, Modeling light, and CANON camera menu accessible is supported.

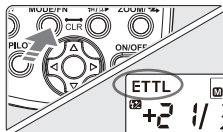

In E TTL mode, you can set exposure compensation for flash by pressing the [+] [-] buttons, the flash exposure compensation range is between -3EV to +3EV, in 1/3-stop or 1/2-stop precision.

4.M Mode

Short press the [MODE] button to switch the flash mode to M mode. In M mode, you can set flash intensity according to your preferences, and adjust flash brightness by short press the [Left], [Right], [Up] and [Down] button. Adjustment range of flash brightness is 1/128~1/1, the intensity totally divided into 8 grades, each has three grades for fine adjustment, and takes 1/3EV as adjustment increment, totally 22-grade fine adjustment at most; adjust whole grade with the [Left] and [Right] button, and make fine adjustment with the [Up] and [Down] button, and the adjustment result will be shown on the LED screen. When shooting, you only need to set flash brightness, adjust the camera and press the shutter; the speedlite will flash according to the sync signal of the camera.

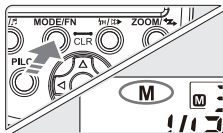

5.Multi Mode

Short press the [MODE] button to switch the flash mode to Multi mode. The Multi mode is stroboscopic mode, in this mode the speedlite will flash according to the output power, flash times and frequency you set. The flash output setting method is the same as M mode. The adjustment scope of output power is 1/128-1/64-1/32-1/16-1/8-1/4. Short press the [OK] button to choose the number of flashes, then press the [OK] button again to choose the flash frequency. The corresponding parameter will blink after selected. Use the [LEFT] and [RIGHT] buttons to adjust output power, flash times and frequency. The scope of flash times is from 1 to 100, and the scope of flash frequency is from 1 to 100.

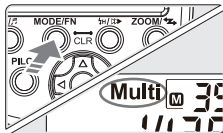

The charging speed of speedlite is slow under the situation that the electricity quantity of the battery is insufficient, which may cause the leakage of the stroboscopic flash. Please reduce the flash frequency or change new battery under this situation.

6.ZOOM: Set the flash range

Auto Zoom: short press the [ZOOM] button until the focal length value displays on LCD panel, then adjust the coverage through the [Left] and [Right] button. When it does not displays < M > in the left of the < ZOOM >

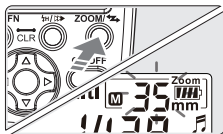

icon, attach the speedlite to the camera, the flash coverage will change as the lens focal length and move back and forth to accommodate different flash coverage (the default is 35mm).

Manually Set the zooming position: Press [ZOOM] button to select focal length value, and adjust the focal length value with [RIGHT] or [LEFT] button. When < M > displays at the left side of [ZOOM] icon, the flash coverage (24, 28, 35, 50, 70, 80, 105mm) can be manually adjusted.

7.Camera Menu Access (Supports More Recent Canon Cameras Only)

When YN568EX III works with the more recent Canon cameras which support ETTL, the speedlite can be operated with camera menu access. In the external flash function setting menu of the flash control menu, and in the custom setting menu of the external flash, the flash parameters, such as ETTL mode, M mode, Multi mode, wireless flash setting, sync method, FEB, FEC, focal length and custom function, can be adjusted.



EOS 60 Camera

8.AF Assist Beam Emitter

When the light is insufficient, half press the shutter, the AF assist beam emitter will be enabled automatically to assist the camera focusing.

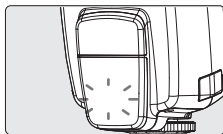

Basic Functions

9. Modeling Flash

When operating the aperture preview button on the camera, the speedlite emits continuous flash for 1 second. That is so-called modeling flash. For more specific operation, please refer to the camera's user manual.



Please try to keep the imaging flashes less than 10 times to avoid the speedlite being overheated or burned out.

10. Power Saving Mode

YONGNUO designs a power saving mode for YN568EX III, and the mode can be achieved through custom function settings. For more details, please refer to the subsequent chapter "Custom Function Setting". When the power saving mode is enabled, the speedlite will be idle for a while and enter into sleep mode. When the speedlite is in sleep mode and still being idle, it will automatically shut down. When the speedlite is in sleep mode, half press the camera shutter or press [PILOT] button to wake up the speedlite.

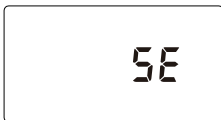

11. Overheat Protection

If the speedlite emits flashes continuously, the internal temperature of the speedlite will increase. When it is up to a certain temperature, the speedlite will display a overheat warning.

When the speedlite emits flashes continuously and frequently, the overheat protection mechanism will be triggered. The LCD panel will display <overheat protection> icon, and the charging indicator lighting in red and blue alternately. After the overheat protection mechanism being

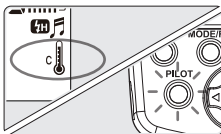

triggered, the speedlite will be locked, and, the parameters and flash cannot be adjusted. In such case, please keep the speedlite idle for 10 minutes or more before continuing use. To prevent the effect on the shooting, please try to use 1/4 output or lower when rapidly shooting is needed.



When the speedlite is used frequently, the flash recycling time will be extended.

When overheat warning icon is displayed, please reduce the flash rate or flash output.

After continuous shooting, please mind the overheated batteries when take them out from the battery compartment.

12.Sound Prompt

When operating custom function setting option, the sound prompt can be enabled or disabled. After the sound prompt is enabled, the speedlite will emit different sound to indicate different working state. For more details, please refer to chapter “Components Description” .

13. PC Sync Port (Input)

By connecting standard 2.5mm sync port, the speedlite can make sync flash.

14.Auto Save

YN568EX III supports saving the current settings automatically, which is convenient for you to use the speedlite next time.

15.Clear Settings

Press [MODE] button and [SYNC] function at the same time, the trigger manner, flash mode, flash intensity, focal length and other parameters can be restored to default setting.

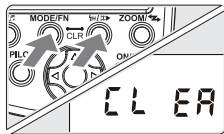

16.Firmware Upgrade

YN568EX III supports firmware upgrade. Users visit official YONGNUO website (www.hkyongnuo.com) to download the latest firmware and update the speedlite. Upgrade method:

- 1.Connect the speedlite to a computer with USB cable (optional).
- 2.When the speedlite is off, keep pressing and holding [MODE] button, at the meanwhile, turn on the power of the speedlite. The speedlite enters into upgrade interface.
- 3.Open the upgrade software and update the firmware of the speedlite accordingly.

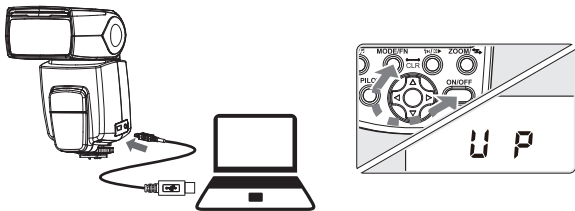

Advanced application

1.High Speed Sync Flash

With high-speed sync (FP flash), the speedlite can be synchronously used with all shutter speed, and the maximum sync speed is up to 1/8000s. High-speed synchronization is particularly convenient when aperture-priority is set to fill flash portrait. Setting methods: Short pressing the function button <SYNC> to turn on or off the HSS function. The HSS icon will display on the LCD screen after HSS function is enabled.

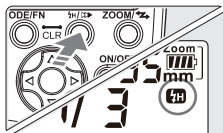

When YN568EX III is used as slave unit, the flash sync method will be controlled by the master unit.

2.Second-curtain Sync

When second-curtain sync function is enabled, the speedlite fires at the moment the shutter is about to close. You can use slow-speed shutter and second-curtain sync to produce trailing smear for the object. To use second-curtain sync function normally, please make sure that your camera supports this function. (For the rear-curtain sync setting, please refer to the user manual of your camera.) Setting methods: short pressing the function button <SYNC> to turn on or off the second-curtain synchronization function.

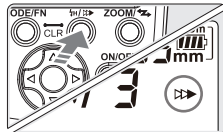

When YN568EX III is used as wireless flash, the second-curtain sync function cannot be set.

3.Remote Wireless Flash

YN568EX III supports remote wireless flash shooting: the furthest distance of indoor wireless

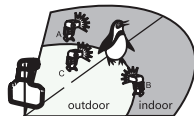

Advanced application

optical transmission can be up to 25 meters while the furthest distance of outdoor is 15 meters.

 When using optical transmission in shooting, the flash works at Sc/Sn, the trigger method, flash mode and flash intensity of the slave unit are controlled by the master unit.

4. Flash Exposure Compensation (FEC)

To meet the needs of shooting effect, you can set the flash exposure compensation through the camera or on the flash. The exposure compensation value is within the range of -3EV~+3EV. The exposure compensation value will be increase by 1/3EV or 1/2EV (The exposure compensation value should be set from camera). By short pressing [RIGHT] or [LEFT] button of the speedlite, the exposure compensation value is adjusted; pressing [OK] button to save the settings.

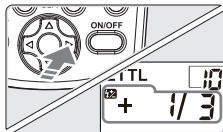

 When the flash, camera and trigger are all set FEC, the FEC value superimposed.

5. Flash Exposure Bracketing (FEB)

The FEB function can be set through the camera or speedlite. After the FEB is set, when every 3 photos are taken, the exposure compensation will be made automatically in the sequence of, for example, “Normal-Under-Over” . This function helps you to improve the success rate of photo taking. The FEB value can be adjusted by short pressing [UP] or [DOWN] button.

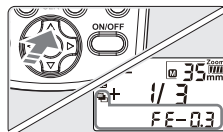

 For FEB, set the drive mode of camera to “single shooting” ; be sure the flash is ready before shooting.

6.FE Lock (Canon)

To use this function, cover the subject for which flash exposure will be locked at the center of the viewfinder of camera, press the button [*] of the flash exposure lock. When the speedlite emits pre-flash, the camera will calculate the appropriate flash output data. At this moment, you have some time to recompose. After re-composition of a picture, press shutter and take photos. (This function can only be used when it's supported by your camera. For the setting method please refer to the user manual of your camera.)

7.FV Lock (Nikon)

When use this function, please set "AE-L/AF-L" function as "FV Lock" . At this time, you can aim at the object in the viewfinder and then press the [AE-L key/AF-L key] , in such case, the speedlite will pre-flash to get the reading of flash exposure for the object. After you confirm the scene frame, press the shutter to take photos. (This function can only be used when it's supported by your camera. For the setting of AE-L and AF-L please refer to the user manual of your camera.)

8.High-speed Continuous Shooting

This speedlite supports high-speed continuous shooting. Please set the camera as "continuous shooting mode" before shooting.



The quantity of photos continuously shoot is related to the set flash intensity. Please use batteries fully charged when you use this speedlite.

9.Reflection Flash

Bounce flash means by making flash head aim at the wall or ceiling, light up the object and shoot with the help of the light reflected from the

Advanced application

ceiling or wall. The shade behind the object will be reduced, and the shooting effect will be more natural.

If the wall or ceiling is too far, the bounce flash is possibly too weak to get enough exposure. To get effective reflection, the wall or ceiling should be even and white. If not, it will result in color cast.

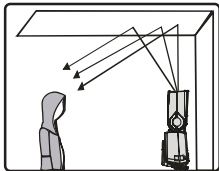

10. Use Reflection Board for Shooting

When using reflection board for shooting, please pull out [reflection board] and [wide-angle panel] from the flash head, and then push [wide-angle panel] back into the flash head. In such case, if this speedlite is

used to take photos, it will produce a highlighted point on the eyes of the subject, and thus make the eyes charming (catching light). This function can reach optimal effect when the flash head is 90 degrees upward.

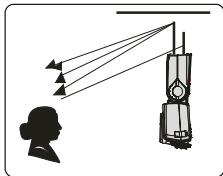

11. Use Wide-angle Panel

Pull out the wide-angle panel, push back the reflection board and place the panel/board as per the picture, the flash range will be extended, and the flash effect will be softer and more natural.

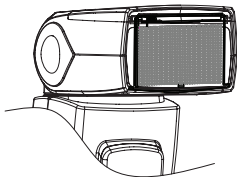

 When using the wide-angle panel, the flash coverage will be extended and locked at 14mm.

Wireless Flash Shooting

YN568EXIII supports optical transmission wireless flash shooting function,it can be used as master unit and slave unit,easily realizes off-camera TTL,M.Multi flash function.The effective distance of wireless flash shooting is :25m ,indoors;15m ,outdoors.

Used as master unit,it can directly trigger Canon's and YONGNUO's EX series flash (except for YN585EX);Used as slave unit,one YN568EX III can receive the optical transmission wireless signal of YN600EX-RT II/YN568EX II/600EX-RT(II)/580EX II,7D/60D/600D internal flash and C-command of Nikon cameras' internal flash respectively.With the optical transmission wireless flash shooting of YN568EX III,it supports up to A.B.C,three groups of slave unit flash control,four channels (CH1/2/3/4)totally for your choice.

▲ Master Unit Setting

Long press the <Z> button for about 2 seconds,enter the trigger selection state which is blinking ,short press [Left] [Right] button until the icon of < MASTER > appears,at this time,short press [OK] to confirm the setting is saved.

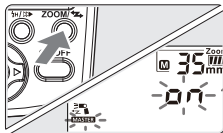

Enter master unit state,short press [MODE] ,the master unit will be switched circularly among the three flash modes of ETTL.M.Multi;Short pressing [ZOOM] for once or for many times can select focal length,channel,light ratio, master control flashing orderly,when one parameter is selected and blinks,the parameter can be adjusted through pressing the [Left] [Right] .Short press [OK] and [Left] [Right] ,you can select the light ratio of A:B or A:B C,the exposure compensation of group C or manual flash output.The method of adjusting exposure compensation and exposure bracketing when the YN568EX III is used as master unit is the same as that of normal on-camera flash.

Optical Transmission Wireless Flash Shooting



In the process of setting the exposure bracketing with [Up] [Down] button, the light ratio is not displayed, the light ratio will resume to be displayed when the setting is finished. However, the light ratio is displayed in the process of exposure bracketing setting of group C and will not be displayed when the setting is finished.

▲ Channel Setting

In the mode of master unit or slave unit, short press [\leftarrow \rightarrow] for multiple times until the <CH> blinks, then press [Left] [Right] to adjust channel (1/2/3/4), press [OK] to save the setting.

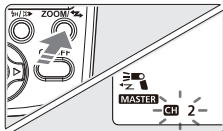

In the shooting with wireless flash, the slave unit and master unit should be in the same channel, otherwise the flash cannot be triggered.

▲ Flash Light Ratio Setting

In the mode of master unit, short press [\leftarrow \rightarrow] for multiple times until the [RATIO] blinks, press [Left] [Right] to select flash group ALL, A:B or A:B C (A:B:C)

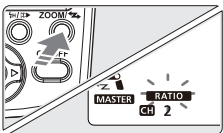

▲ Flash Turn-on or Turn-off of Master Control Flash

In the mode of master unit, short press [\leftarrow \rightarrow] until it blinks as shown in the picture on the right, press [Left] [Right] to turn on (on) or off (oF) the master control flash.

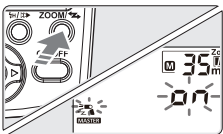

▲ Adjustment of Light ratio.Manual Flash Output of All Groups.Stroboscopic Flash Output.Stroboscopic Flash Times and Frequency.

In the mode of master unit,short press [OK] to choose the group of the parameters which need to be adjusted,then press [Left] [Right] to adjust the parameter,then press [OK] to save setting.

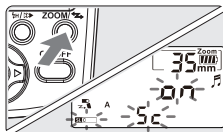
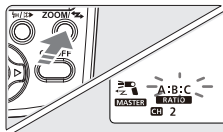

▲ Slave Unit Setting

Press [↔] until the LCD displays <SLCH12> to enter the mode of the optical transmission wireless slave unit.When the YN568EX III is used as the optical transmission wireless slave unit,there are four trigger modes,Sc/Sn/S1/S2 for you to choose.



In the shooting with wireless flash,try to place the wireless sensor of the slave unit towards the master unit and make sure the slave unit is in the effective range for being triggered.

Sc/Sn trigger modes can receive the optical transmission wireless signal of YONGNUO YN600EX-RT II/YN568EX II/YN568EX III/Canon's 600EX (II) -RT/580EX II,internal flash of 7D/60D/600D,C-command of Nikon cameras' internal flash respectively to achieve off-camera TTL and manual flash functions.

Sc trigger mode: accepts Canon's optical transmission wireless signal only.

Sn trigger mode: accepts Nikon's optical transmission wireless signal only.

Optical Transmission Wireless Flash Shooting



When the YN568EX III works in the Sc.Sn trigger mode,the flash mode and brightness of the slave unit is fully controlled by the master unit.

S1/S2 trigger mode applies to manual flash environment and TTL flash environment respectively.When YN568EX III works in S1/S2 trigger mode,the flash modes defaults to M mode,the setting of flash output is the same as that of normal on-camera flash.

S1 mode: In the S1 mode,it triggers flash synchronously with the first flash of the master flash ,the effect of which is the same as that of wireless flash trigger.In order to work with this mode properly,the master flash should be set to manual flash,do not use TTL flash system with pre-flash function or the Red-eye reduction function with multiple flashes.

S2 mode: Also called 'pre-flash cancel mode',which is similar to S1 mode,but it can ignore the pre-flash sent out by TTL flash,in this way it can support the master flash in TTL mode.In particular,if in S1 mode,the flash cannot flash with your internal flash properly and synchronously,try using S2 mode.



The following situations should be avoided in S1,S2 mode,red-eye reduction function of the master flash is used;
the optical wireless flash mode of the master flash is used;the ST-E2 is used as flash controller; Otherwise,the flash might be out of sync accordingly.

C.Fn:Custom function settings

Long press [MODE] to enter self-defined functions setting,short press [Up] [Down] to choose self-defined items,short press [Left] [Right] to alter sub-option,when the self-defined setting is finished,press [OK] to save and exit current settings.

Advanced Options that YN568EX III supports are as follows:

Fn NO.:01

SL EP on: Power saving function is on.

SL EP --: Power saving function is off.

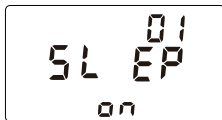

Fn NO.:03

Fb CL on: FEB automatic cancellation is on.

Fb CL --:FEB automatic cancellation is off.

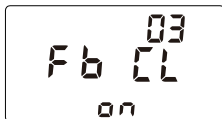

Fn NO.:04

Fb 0 - +: Sequence of FEB is "0→--→+"

Fb - 0 +: Sequence of FEB is "--→0→+"

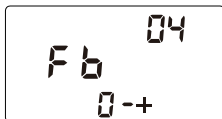

Fn NO.:08

AF on: AF assist is on.

AF --:AF assist is off.

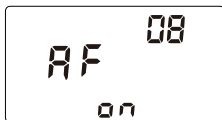

Fn NO.:09

AP S A1: Automatic image size identification is on.

AP S --: Off

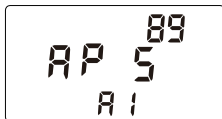

C.Fn:Custom function settings

Fn NO.:10

SL Sd 10: Idle time before sleep for slave unit is 10 minutes

SL Sd 60: Idle time before sleep for slave unit is 60 minutes

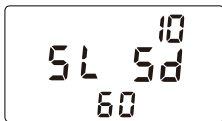

Fn NO.:11

SL oF 1H: Idle time before sleep for slave unit is 1 hour.

SL oF 8H: Idle time before sleep for slave unit is 8 hours.

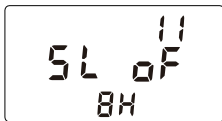

Fn NO.:20

So nd on: Sound prompt function is on.

So nd - -: Sound prompt function is off.

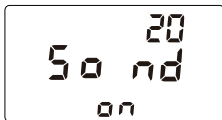

Fn NO.:E1

SE oF 3/5/10/30/1H/2H/3H/4H/5H : represents the idle time before sleep for the flash is 3 minutes/5 minutes/10 minutes/30 minutes/1 hour /2 hours/3 hours/4 hours /5 hours respectively,after sleep,it keeps idle for

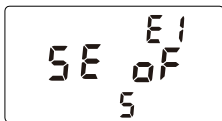

the same time aforementioned and powers off automatically.

SE of --: No sleep,no auto power-off.

Fn NO.:E2

qu ic --: Turn off quick turn-on /shut-down function (default)

qu ic on: Turn on quick turn-on /shut-down function

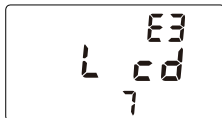
**Fn NO.:E3**

L cd 7/15/30: The display time of the flash LCD back light is 7/15/30 seconds.

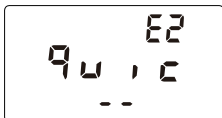
**Fn NO.:E4**

CL EA --: Restore advanced options default setting(long press OK button to restore default settings.)

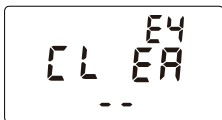
**Fn NO.:E5**

VEr 1.00: Display of the current version of the flash.



Troubleshooting guide

1.Unable to power on or flash

Please check if the batteries are installed properly,or the battery power is enough;When using external battery pack,the flash also needs to be installed with four AA batteries.Please make sure the hot shoe of the flash inserted completely to the hot shoe socket of the camera and lock the locking ring of the flash tightly;If the hot shoe contact of the flash or camera is dirty,please clean the contact.

2.Flash powers off automatically

Please check if the power saving function of the flash is on or the battery power is enough.

3.Unable to flash in optical transmission wireless shooting

For outdoor shooting,please protect the wireless sensor of the flash from direct sunlight;Make sure the master unit and slave unit are in the same channel,and the slave unit is within effect wireless transmission range of the master unit.

4.Underexposure and overexposure of photos

Please check if the settings of the camera,the shutter, aperture and ISO are too close to the limit of the flash,or the settings concerned with the flash such as the exposure compensation , exposure bracketing of the camera or the flash are correct.

5.Dark corner of photo appears or only part of the object is illuminated.

Please check the current flash coverage of the flash;please check if the lens focal length is out of the flash coverage,if it is ,you can try pulling the wide-angle diffuser to extend the flash coverage.

6.Other problems of the flash

Please try to clear the settings of the flash and camera,or turn off and on the flash and camera.If the problems still exist,please contact YONGNUO After-Sale Service Hot line 400-0013-888 or email to service@hkyongnuo.com for help.

Specification

Circuit design	Insulated Gate Bipolar Translator (IGBT)
Guide No.	58 (ISO 100, 105mm)
Flash mode	TTL, M, Multi
Trigger mode	On-camera /Sc, Sn, S1, S2
Zoom range	24, 28, 35, 50, 70, 80, 105mm
Vertical rotation angle	-7~90 degrees
Horizontal rotation angle	0~270 degrees
Power supply	4xAA alkaline battery or AA NI-MH battery
Flash times	100~1500 times (with AA alkaline battery)
Recycle time	Approx.2s (with AA alkaline battery)
Color temperature	5600k
Flash time	1/200s~1/20000s
Flash control	8 levels of output control(1/128~1/1),29 Levels of fine tuning in total
External interface	Hot shoe,PC port,USB port
Wireless trigger distance	20~25 indoors,10~15 outdoors
Additional functions	Master flash, High-speed sync,Rear-curtain sync,FEC,FEB, FE lock,electric zoom of flash head,sound prompt,auto-save setting,PC sync, USB port,power saving mode,overheating protection,advanced options setting.
Dimensions	62×72×188mm (extended state)
Net weight	350g
Items contained	flash (1) ,protecting bag (1) ,tiny base (1) , user manual (1)

Specification

Guide number of different focal range (ISO 1000,in meters/feet)

Flash output	Flash coverage (mm)			
	14	24	28	35
1/1	15/49.2	28/91.9	30/98.4	36/118.1
1/2	10.6/34.8	19.8/65	21.2/69.6	25.5/83.7
1/4	7.5/24.6	14/45.9	15/49.2	18/59.1
1/8	5.3/17.4	9.9/32.5	10.6/34.8	12.7/41.7
1/16	3.8/12.5	7/23	7.5/24.6	9/29.5
1/32	2.7/8.9	4.9/16.1	5.3/17.4	6.4/21
1/64	1.9/6.2	3.5/11.5	3.8/12.5	4.5/14.8
1/128	1.3/4.3	2.5/8.2	2.7/8.9	3.2/10.5

Flash output	Flash coverage (mm)			
	50	70	80	105
1/1	42/137.8	50/164	53/173.9	58/190.3
1/2	29.7/97.4	35.4/116.1	37.5/123	41/134.5
1/4	21/68.9	25/82	26.5/86.9	29/95.1
1/8	14.8/48.6	17.7/58.1	18.7/61.4	20.5/67.3
1/16	10.5/34.4	12.5/41	13.3/43.6	14.5/47.6
1/32	7.4/24.3	8.8/28.9	9.4/30.8	10.3/33.8
1/64	5.3/17.4	6.3/20.7	6.6/21.7	7.3/24
1/128	3.7/12.1	4.4/14.4	4.7/15.4	5.1/16.7

The electronic version of this manual can be obtained from www.hkyongnuo.com.

The functions on this manual are obtained based on the test conditions of our company. Further notice will not be given if there are any changes for the design and specification. The YONGNUO logo on this manual is registered trademark owned by SHENZHEN YONGNUO PHOTOGRAPHIC EQUIPMENT Co., Ltd. in China or other countries (regions). All other trademarks are the property of their respective owners.